



Meaningful Innovation.

WEEE Number: 80133970

INSTRUCTION MANUAL

LED SENSOR DOME LIGHT



02 YEAR WARRANTY* **IP44 RATING** **SPHERE 360° DAY LIGHT**

TECHNICAL DATA

MODEL	SKU	WATTS	LUMENS	BEAM ANGLE	BODY TYPE	CRI	LIFE SPAN	ON/OFF CYCLE	TOTAL CURRENT	INPUT VOLTAGE	SHAPE	DIMENSION (LxWxH)
VT-8618S	76591	18W	1830LM	Sphere 360°	PP+PMMA	>80	20,000 Hours	>15,000	130mA	AC:220-240 50/60Hz	ROUND	ø295 x 60mm
	76601										SQUARE	295x295x65mm
76611	ROUND										ø350 x 61 mm	
76691	SQUARE										295x295x65mm	
VT-8624S	76621	24W	2500LM	Sphere 360°	PP+PMMA	>80	20,000 Hours	>15,000	170mA	AC:220-240 50/60Hz	ROUND	ø350 x 61 mm
	76631										SQUARE	295x295x65mm
76641	ROUND										ø420 x 65 mm	
76701	SQUARE										420x420x65mm	
VT-8630S	76651	36W	3820LM	Sphere 360°	PP+PMMA	>80	20,000 Hours	>15,000	160mA	AC:220-240 50/60Hz	ROUND	ø420 x 65 mm
	76661										SQUARE	420x420x65mm
76681	ROUND										ø420 x 65 mm	
76711	SQUARE										420x420x65mm	

SENSOR TECHNICAL DATA

DIMENSION	INPUT POWER	STANDBY POWER	WORKING FREQUENCY OF RADAR MODULE	INSTALLATION HEIGHT
20mm*20mm*2.6mm	DC: 5V	5V @ <30mA	5.8GHz ± 5.87GHz	3m
DETECTION RADIUS	INITIALIZATION TIME	HOLDUP TIME	WORKING TEMPERATURE	AMBIENT LIGHT THRESHOLD
1-5m	3 sec	Adjustable	-20°C ~ 85°C	Adjustable

*This product contains a light source of energy efficiency class <F>, where <F> shall be replaced by the energy efficiency class of the contained light source.

INTRODUCTION & WARRANTY

Thank you for selecting and buying V-TAC product. V-TAC will serve you the best. Please read these instructions carefully before starting the installation and keep this manual handy for future reference. If you have any another query, please contact our dealer or local vendor from whom you have purchased the product. They are trained and ready to serve you at the best. The warranty is valid for 2 years from the date of purchase. The warranty does not apply to damage caused by incorrect installation or abnormal wear and tear. The company gives no warranty against damage to any surface due to incorrect removal and installation of the product. The products are suitable for 10-12 Hours Daily operation. Usage of product for 24 Hours a day would void the warranty. This product is warranted for manufacturing defects only.

WARNING

- Please make sure to turn off the power before starting the installation.
- Installation must be performed by a certified person.
- The light source of this luminaire is not replaceable, when the light source reaches its end of life the whole luminaire should be replaced.
- For Indoor use only
- If the external flexible cable or cord of this luminaire is damaged, it shall be exclusively replaced by the manufacturer or his service agent or a similar qualified person in order to avoid a hazard.
- Method of attachment of the cable or cord such that any replacement can only be made by the manufacturer, his service agent or similar qualified person.

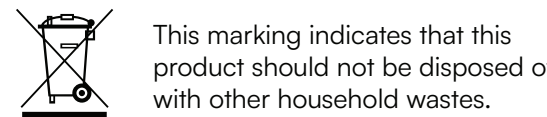

This marking indicates that this product should not be disposed of with other household wastes.

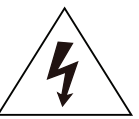

Caution, risk of electric shock.

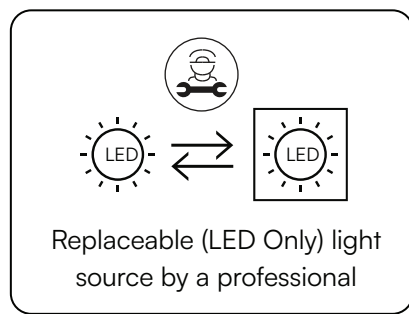

Replaceable (LED Only) light source by a professional



MULTI-LANGUAGE MANUAL QR CODE

Please scan the QR code to access the manual in multiple languages

INSTALLATION DIAGRAM

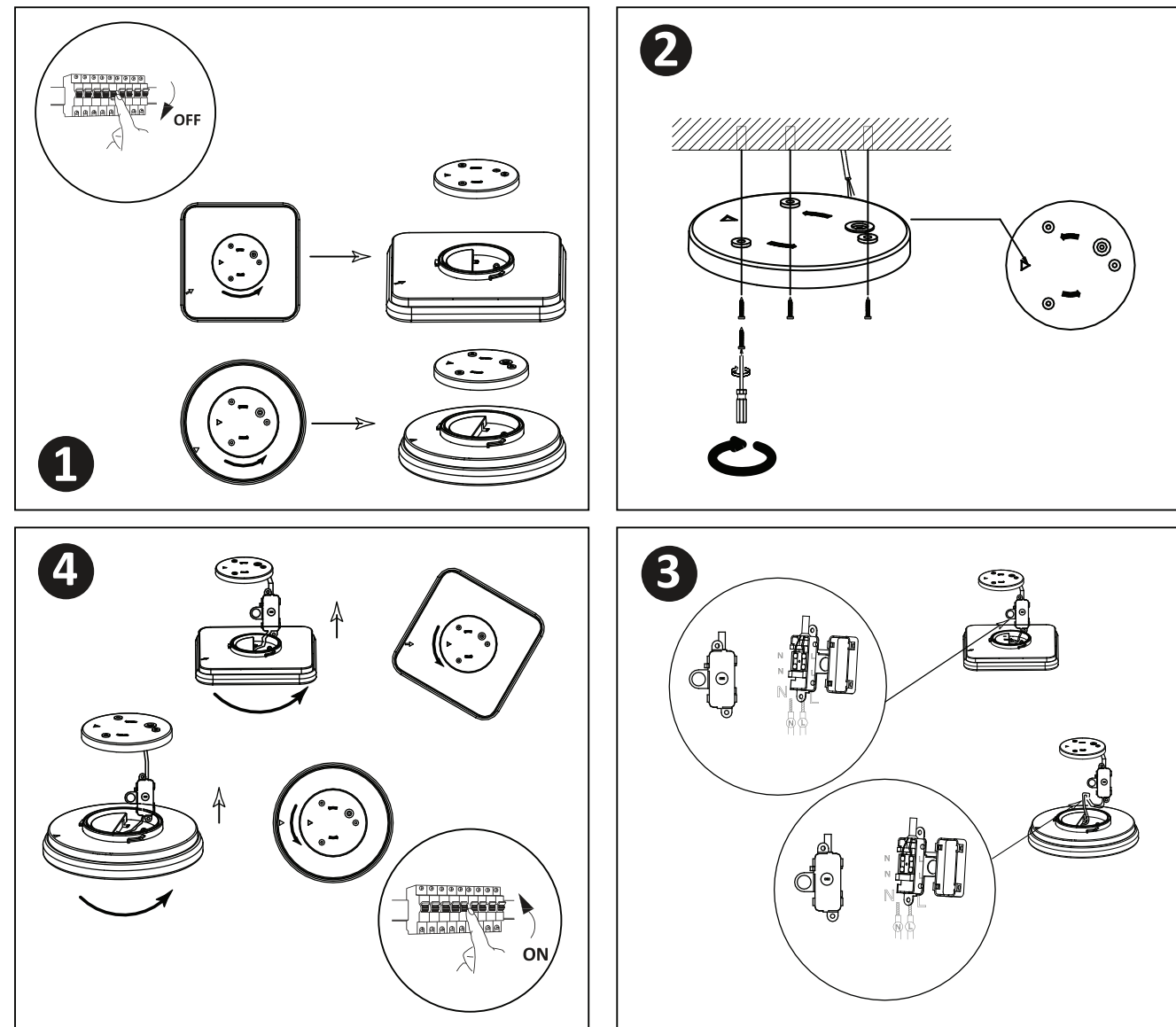

DISASSEMBLY DIAGRAM

(For Market surveillance team only)

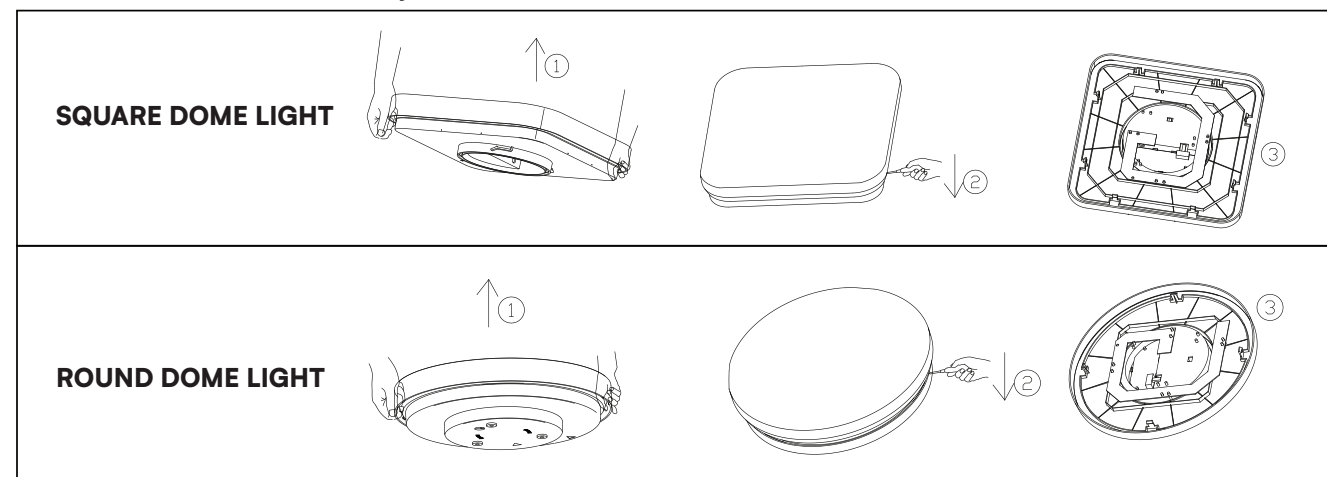

Note: Light source removal will void the warranty

REMOTE CONTROLLER INSTRUCTIONS

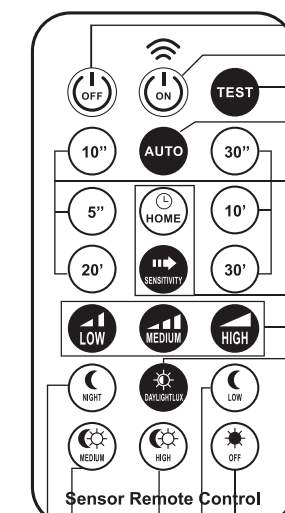

- OFF WITH MEMORY FUNCTION
- ON
- REPEATED FLASHING MODE: TURN ON THE LIGHT FOR 500MS, THEN TURN OFF THE LIGHT FOR 500MS, AND KEEP REPEATING THIS STATE
- AUTOMATIC MODE: 100% SENSING DISTANCE, TURN OFF PHOTOSENSITIVE FUNCTION, HOLD TIME FOR 30 SECONDS
- SENSOR HOLD TIME: 10S, 30S, 5MIN, 10MIN, 20MIN, 30MIN
- N/A
- SET THE SENSING DISTANCE LEVEL TO THE LOWEST: INSTALLATION HEIGHT OF 3M, SENSING RADIUS OF 1-2M
- ADJUST THE SENSING DISTANCE LEVEL TO MEDIUM: INSTALLATION HEIGHT OF 3M, SENSING RADIUS OF 2-3M
- ADJUST THE SENSING DISTANCE LEVEL TO HIGHEST: INSTALLATION HEIGHT OF 3M, SENSING RADIUS OF 4-5M
- TURN OFF PHOTOSENSITIVE FUNCTION
- ADJUST THE PHOTOSENSITIVE THRESHOLD TO 30LUX
- ADJUST THE PHOTOSENSITIVE THRESHOLD TO 200LUX
- ADJUST THE PHOTOSENSITIVE THRESHOLD TO 100LUX
- ADJUST THE PHOTOSENSITIVE THRESHOLD TO 5LUX

SENSOR INFORMATION

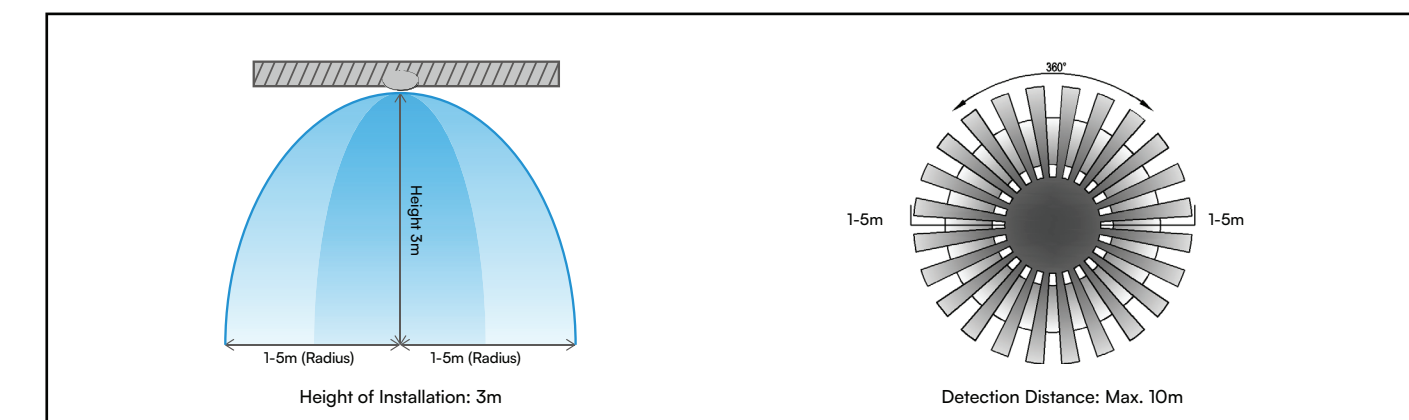

SENSOR USAGE

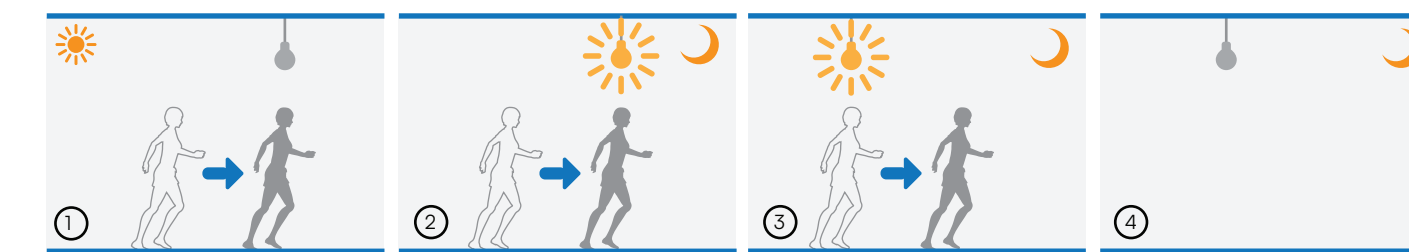

- When the ambient light is bright enough, even if a moving object is detected, the lamp will not automatically light up
- When the ambient light is lower than the preset photosensitive threshold, the light will automatically light up when the sensor detects a moving object
- When the sensor cannot detect the moving object after the moving object leaves, it will enter the delay time and keep the light on
- After the moving object leaves and after the preset delay time, the lamp will automatically turn off

TEST METHOD

- Start Up Phase**
- The microwave lamp shall be installed at a height of 3M above the ground to ensure that the front induction antenna is horizontally downward, i.e. in the direction of the ground;
 - Power on;
 - The microwave induction module is connected to the power supply. At this time, the module continuously outputs the high level for self inspection for 4S. After the self inspection is completed, the module continuously outputs the low level and enters the working state.
- Intelligent Control Stage:**
- When someone enters the microwave induction coverage range (1-5 meters can be customized), the microwave induction module outputs a high level;
 - If someone is active in the microwave coverage area, the induction module always outputs a high level;
 - When a person leaves the microwave coverage range for 1 minute, the induction module outputs a low level

- Test precautions and special instructions:**
- During the test (especially when the technician tests the sample, the product must be placed on the table top and the antenna surface must be upward), the person must be at least 1m away from the table top.
 - When the light is off, the radar silence time of 1 second is required to be triggered again;
 - During the test, try to eliminate external interference factors, such as the movement of the machine and people or the movement of the partition wall, and prevent low-frequency resonance, false alarm and misjudgment;
 - The delay time refers to the time interval from the start to the end of the last sensing signal, and the countdown after the person leaves the sensing area;
 - Traditional products are not suitable for long-distance applications installed in a narrow space
 - The above delay time, distance and photosensitive parameters can be appropriately modified according to customer requirements.

- Supplementary Note:**
- Warning:** If signal output port (IFI / IFQ) is sensitive to ESD (electrostatic damage), contact with high electrostatic area or power area may cause irreversible damage to the radar module
- Warning:** If the lamps have been matched (not limited to brands and models) in the development stage, please do not replace other unmatched equipment (including but not limited to power supply and lamps) during use. If the equipment is replaced without authorization and there is any abnormality, our company will not be responsible.
- Suggestion:** It is recommended to use qualified DC stabilized power supply, i.e., DC stabilized power supply with output voltage, current and ripple coefficient up to standard, otherwise the stability of this product will be affected and some abnormalities may occur, such as false alarm, no induction, circulation and self start-up.

- Matters Needing Attention**
- Avoid installing metal accessories or shells, which will shield the microwave and affect the effect;
 - The antenna surface shall be protected from high current circuit coverage, which may cause interference;
 - The photosensitive position shall be protected from opaque objects, which will change the photosensitive intensity;
 - The recommended installation distance of the sensor is greater than 1.5m.

